



EXTRUSION SYSTEMS
FOR HIGH PRESSURE COMPOSITE PIPES
WINDING TECHNOLOGY

profiline s-series



The product application

**First, we imagine the perfect product.
Second, we design the perfect machinery.**

There is a good reason why we first show the product of our machinery and its application, before we show details of the extrusion line. We are not only a machinery company, together with our machinery customers we also have experience in pipe production, marketing and installation of plastic pipe systems world-wide since the year 1956. Until today we support our customers in regard to engineering and installation in highly developed projects.

We are always looking for a product improvement first before we are changing the machinery design.

Our customers can rely on the fact that we never forget about the practical use of every innovation for the final product application.

Besides different diameters, fibres or steel reinforcement and pressure rates, we also look at the most efficient and best quality jointing method for our composite pipes.



- 1 DN 1800 sea outfall line, 4 bar pressure
- 2 DN 1800 sea outfall line, 4 bar pressure
- 3 DN 2000 sewer line in treatment plant, 2 bar pressure

In addition to the possibility to extrude solid wall pressure pipes from PE100 or PP, our machinery also offers the use of composite materials like textile fibres, glass fibre or steel wires. The composite pipe increases the stability for inside pressure and reduces the material consumption of PE100 or PP by up to 40 %.

The unique bauku technology is optimized for the production of large diameter pressure pipes from DN 800 to DN 4000.

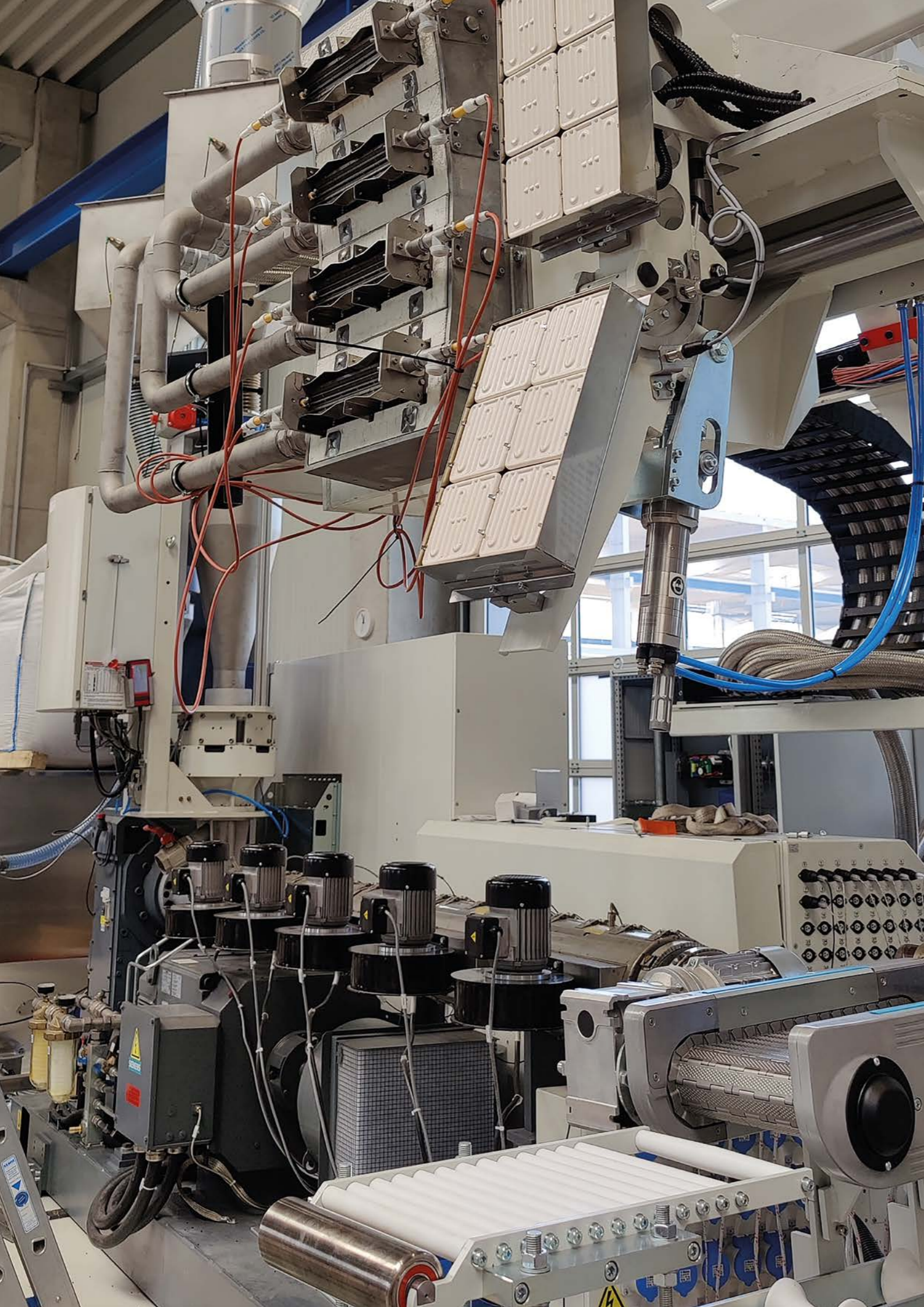

The machinery

When bauku in Germany started the pipe production in year 1956, the winding process was invented. First the main customer was the industry needing tanks for the storage of aggressive chemicals. Due to the hydrostatic pressure inside, pipes for tanks have been manufactured from solid wall HDPE and PP grades. The industry also asked for pipelines with high inside pressure, jointed with extrusion welding or butt fusion welding.

Our extrusion line type proffiline s-series is designed to produce all pipes from diameter DN 800 to diameter DN 4000. The only tool which has to be exchanged is the steel mandrel, which is the inner form for the extruded pipe. The basic extrusion line comes with just one winding station and a mandrel selection by the customer. The efficiency of the extrusion line can be increased by the investment in a second and a third winding station. More mandrels with different diameters can be added any time.

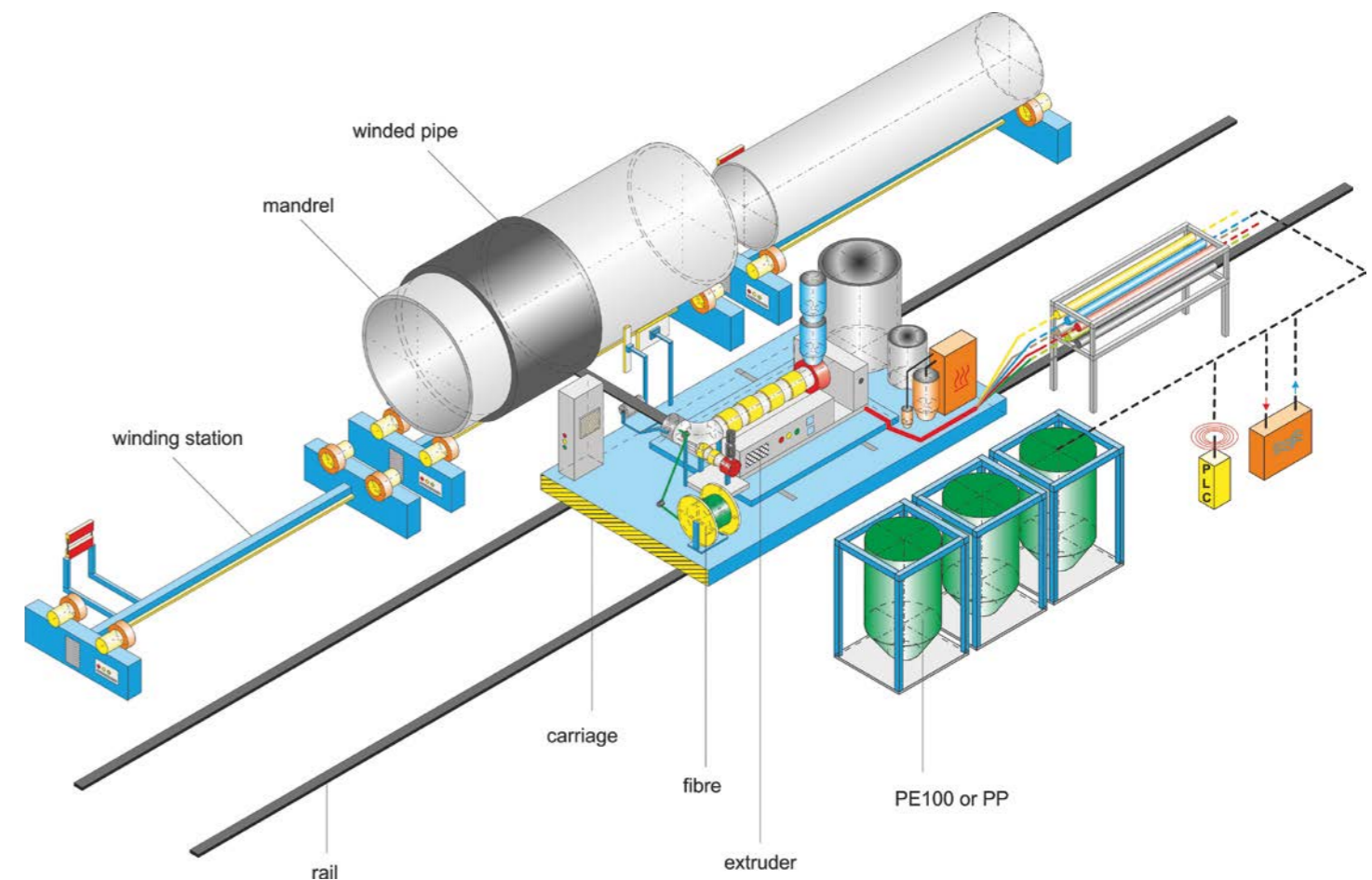
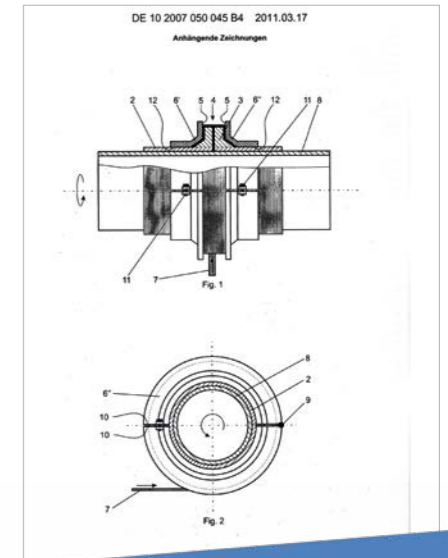
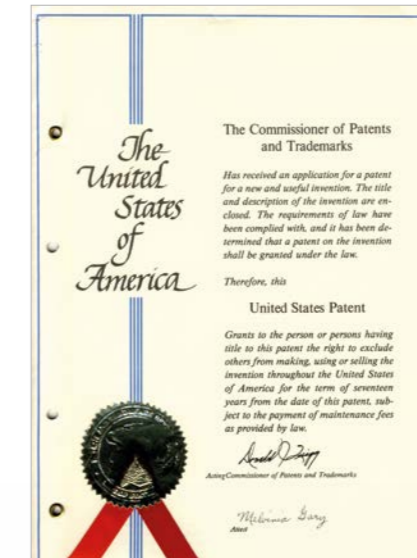

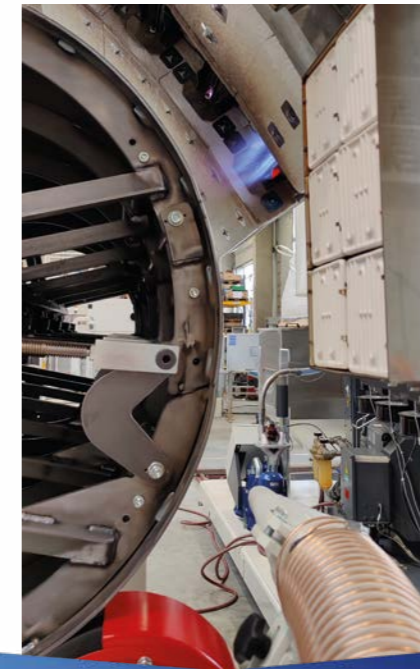

- 9 Trial production at our factory in Lindlar, Germany
- 10 Telescopic tower for the main gas heating system
- 11 Start-up of winding process, PE100, first layer
- 12 Pre-heating of mandrel DN 1000
- 13 Winding of first solid wall layer, DN 1000

The extruder on the carriage moves along the winding station with the rotating mandrel. Both movements end in a spiral winding process, which is typical for the bauku technology. The flat solid wall profile can be up to 250 mm in width and up to 12 mm in thickness. This large profile allows a production speed of up to 1.500 kg/hour, depending on the extruder type.

The carriage drives forward and backward during the winding process, so the number of layers on the mandrel can be adjusted according to the necessary final wall thickness of the solid wall pipe. Normally the wall thickness is determined by the inner pressure of the pipe. The usual pressure classes, SDR or ESDR classes are:

- 5,5 bar, SDR 33
- 6,9 bar, SDR 26
- 10,0 bar, SDR 17
- 16,0 bar, SDR 11

Our flexible extrusion process can also manufacture pipes with a higher-pressure rate or rates between the classes.

To change from one diameter to another diameter is only a change of the mandrel at a winding station. The die head and the profile tools do not need any change, not even if the width of the extruded profile or the thickness of the profile must be adjusted.

This unique design of the production line makes the manufacturing process flexible enough, to produce also small numbers of pipes of just one diameter and one wall thickness very economical. The number of winding stations and the number of mandrels support a production sequence, where different diameters and different pipe profiles are extruded in a mixture - without any waiting time or production break down.

Pipes with high inside pressure large diameters should be jointed with the welding method. While the extrusion welding process may be suitable for lower pressure rates up to 4 bar, higher pressure rates should be supported by the butt fusion welding. This welding process is the perfect choice for axial extruded pipes and is also suitable for winding pipes.

Our pipes are tolerated from the inside

As we use mandrels as an inside forming element, our pipes are always tolerated from the inside. A change in the wall thickness means a change in the outside diameter, while the inside diameter is constant.

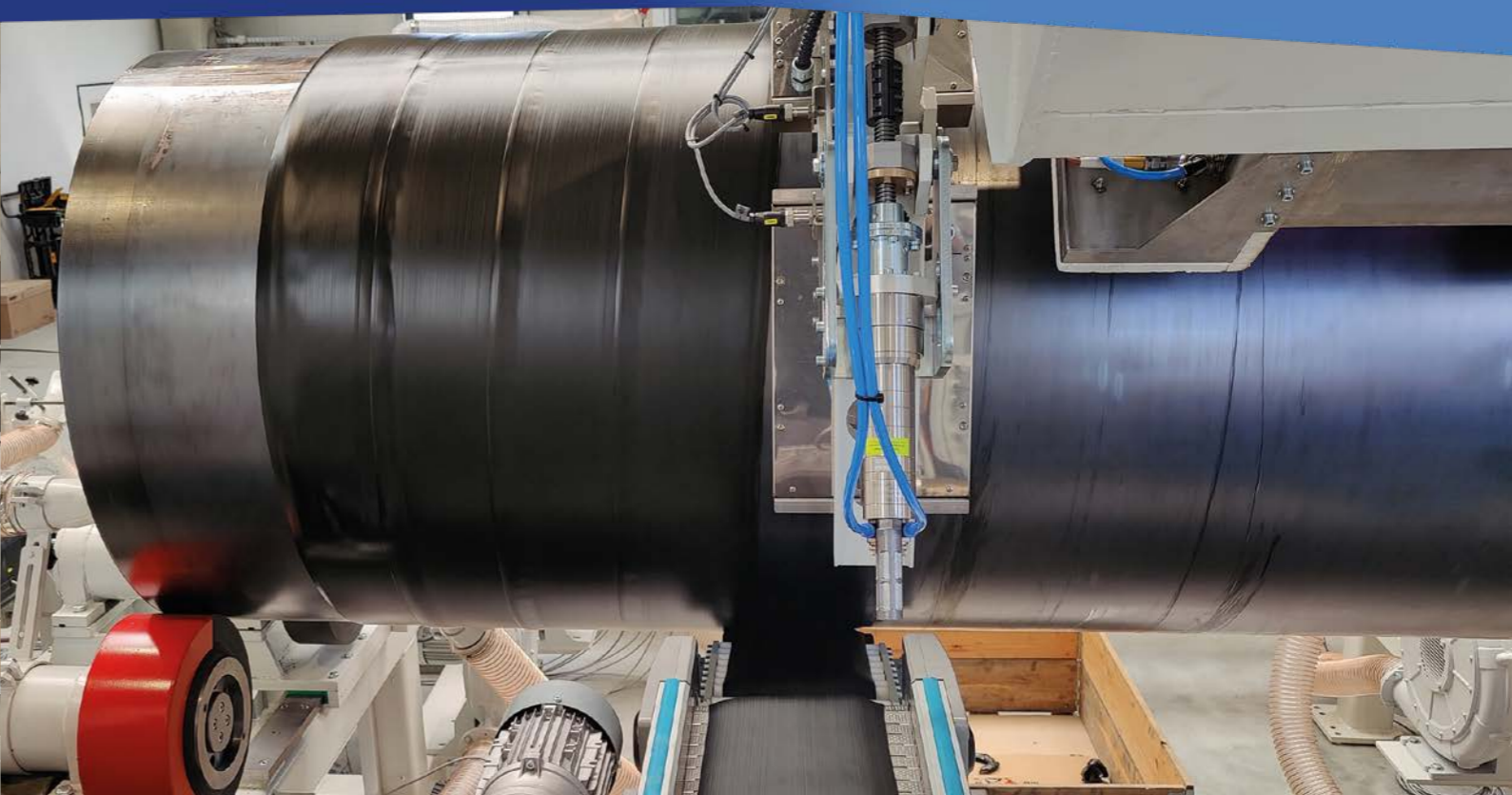

The production cycles

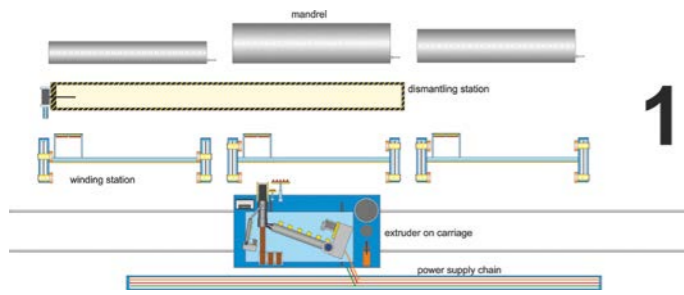

1

Starting up the pipe productions means first of all, that the selected mandrels for a production sequence are prepared.

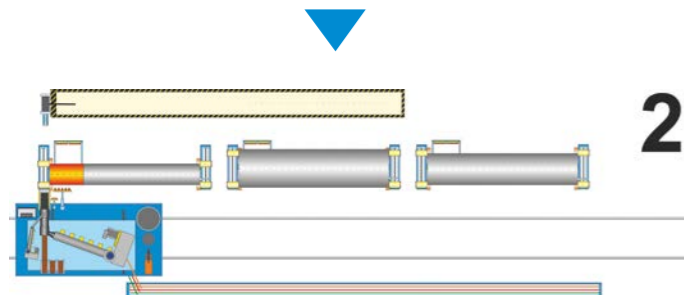

2

Once the mandrels are on the winding stations, the carriage moves to the first station, where the station heaters (optional) already heated up the mandrel surface to approx. 220 °C.

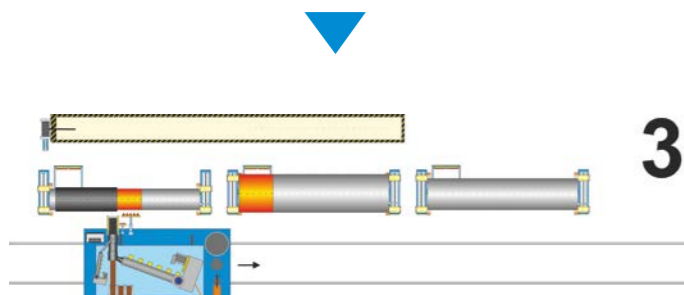

3

The winding of the solid wall (or composite) profile starts with the first layer. The second mandrel is already warmed up.

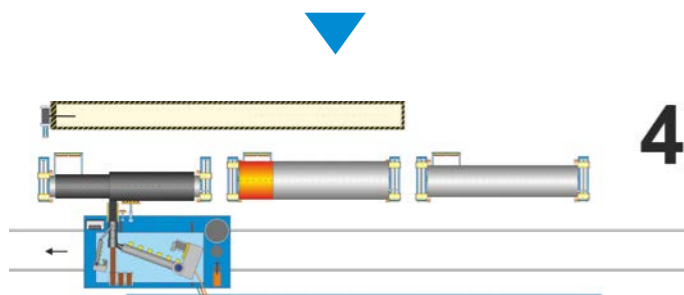

4

The carriage with the extruder is moving forward and backward, until the designed wall thickness of the pipe is reached.

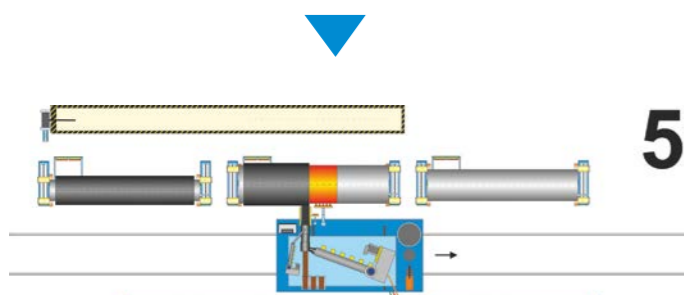

5

The winding process starts at the second mandrel, which may have a different diameter and a different wall thickness.

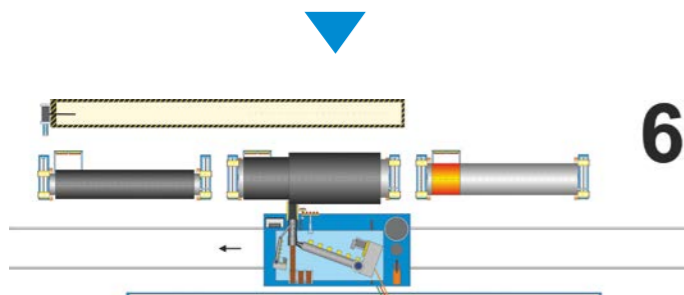

6

The second pipe is extruded in several layers, until the final product design is finished.

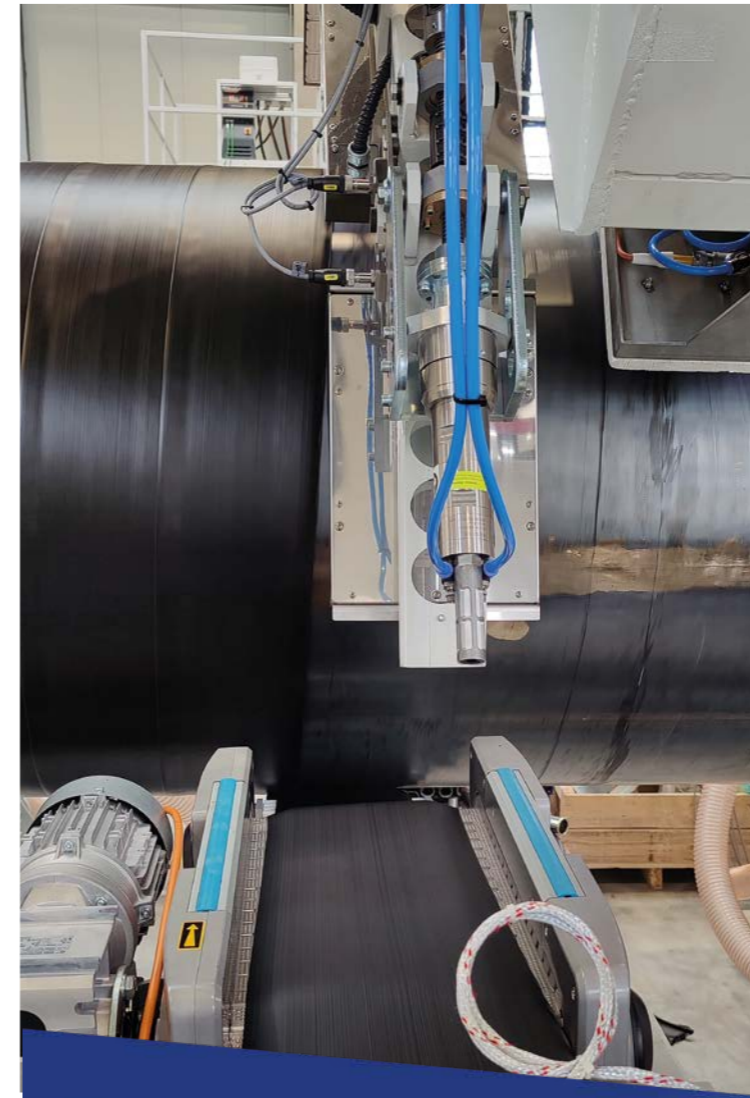

While the third pipe is under production, the first pipe is dismantled from the mandrel. The mandrel is going back to the first winding station for the next production sequence.

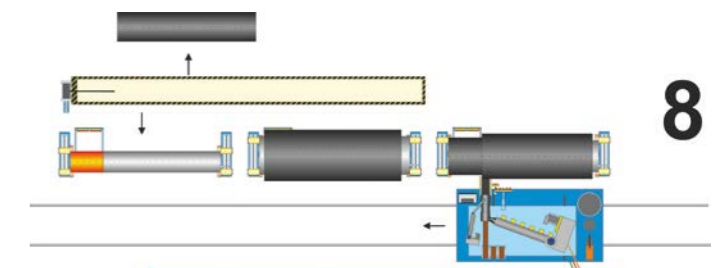

8

The winding of the third pipe starts, the first pipe (with the mandrel inside) already cooled down and is transported to the dismantling station.

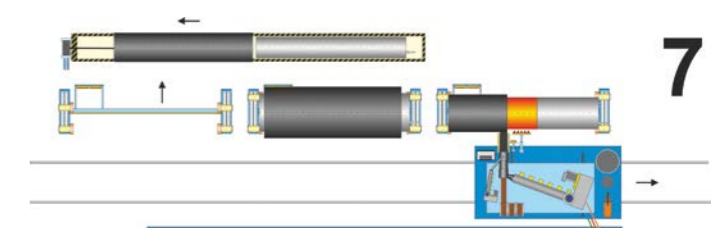

7



The composite pipe

The extrusion lines are able to use a fibre or a steel reinforcement.

The profilline s-series offers the possibility to manufacture a composite pipe, made from different materials. Still the PE 100 is the main material in the pipe wall, but a glass fibre or textile fibre or a steel wire can be included in the wall. Typical PE100 grades have an e-modulus of 1.100 N/mm². A glass fibre rod reaches about 27.000 N/mm², a steel wire even has 210.000 N/mm².

The reinforcement increases the inside pressure resistance of the PE100 pipe wall dramatically.

Up to 40 % material saving

The composite structure offers up to 40 % material saving for the PE100 compared with a conventional solid wall pipe with the same inside pressure rate. The result is not only a cost saving, but also less overall weight of the pipe, easier handling and an easier welding process.

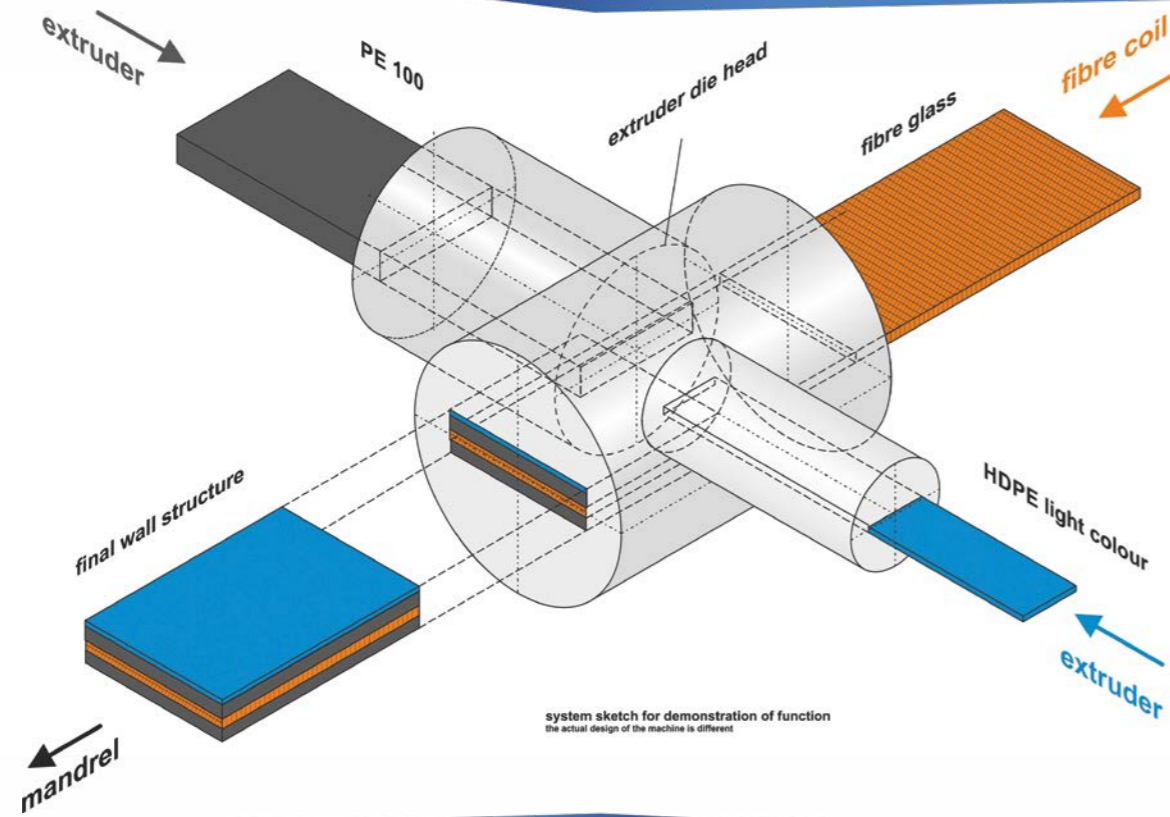

PE100 + fiber		PE with density 959 [kg/m ³]					
DN [mm]	safety PE [factor]	ESDR 33	ESDR 26	ESDR 17	ESDR 11		
1100	1,1	20,0	26,0	41,0	68,0	wall thickness	[mm]
		67,5	88,2	140,9	239,3	weight PE	[kg/m]
		18.000,0	24.000,0	39.000,0	66.000,0	E-Modulus PE	[N/mm]
		25.623,8	25.623,8	25.623,8	25.623,8	E-Modulus Comp.	[N/mm]
	1,1	1,0	2,0	2,0	3,0	fiber layer	[no]
		351,9	353,7	358,5	366,9	fiber	[m/m pipe]
		1,8	1,8	1,8	1,9	weight fiber	[kg/m]
1200	1,1	22,0	28,0	44,0	74,0	wall thickness	[mm]
		81,0	103,6	164,9	284,0	weight PE	[kg/m]
		20.000,0	26.000,0	42.000,0	72.000,0	E-Modulus PE	[N/mm]
		25.623,8	25.623,8	25.623,8	25.623,8	E-Modulus Comp.	[N/mm]
	1,1	1,0	2,0	2,0	3,0	fiber layer	[no]
		383,9	385,8	390,8	400,2	fiber	[m/m pipe]
		2,0	2,0	2,0	2,1	weight fiber	[kg/m]
1300	1,1	24,0	31,0	48,0	80,0	wall thickness	[mm]
		95,7	124,3	194,9	332,6	weight PE	[kg/m]
		22.000,0	29.000,0	46.000,0	78.000,0	E-Modulus PE	[N/mm]
		25.623,8	25.623,8	25.623,8	25.623,8	E-Modulus Comp.	[N/mm]
	1,1	1,0	2,0	2,0	4,0	fiber layer	[no]
		415,9	418,1	423,5	433,5	fiber	[m/m pipe]
		2,1	2,2	2,2	2,2	weight fiber	[kg/m]
1400	1,1	26,0	33,0	52,0	86,0	wall thickness	[mm]
		111,7	142,5	227,5	385,0	weight PE	[kg/m]
		24.000,0	31.000,0	50.000,0	84.000,0	E-Modulus PE	[N/mm]
		25.623,8	25.623,8	25.623,8	25.623,8	E-Modulus Comp.	[N/mm]
	1,1	2,0	2,0	3,0	4,0	fiber layer	[no]
		448,0	450,2	456,2	466,8	fiber	[m/m pipe]
		2,3	2,3	2,3	2,4	weight fiber	[kg/m]
1500	1,1	27,0	35,0	55,0	92,0	wall thickness	[mm]
		124,2	161,9	257,7	441,3	weight PE	[kg/m]
		25.000,0	33.000,0	53.000,0	90.000,0	E-Modulus PE	[N/mm]
		25.623,8	25.623,8	25.623,8	25.623,8	E-Modulus Comp.	[N/mm]
	1,1	2,0	2,0	3,0	4,0	fiber layer	[no]
		479,7	482,2	488,5	500,1	fiber	[m/m pipe]
		2,5	2,5	2,5	2,6	weight fiber	[kg/m]
		126,7	164,4	260,2	443,9	weight PE+fiber	[kg/m]
		5,5	6,9	10	16		
		PN [bar]					
valid for 20°C, 50 years operation, safety factor 1,25							

The unique design of our die head supports different fibres. Together with our customers we find the best solution for the region and the available composite materials.

We always design a solution, in which the fibre is concentrated in just a thin layer in the middle of the PE 100 structure. This method guarantees the necessary PE thickness for a high-quality welding.

The table above is just an example for a selection of diameters for a special glass fibre with a defined size and strength. Additional technical values for smaller and larger diameters are available on request. The values given here are non-binding and may change with technical progress.

The flexibility in the kind of fibre or steel wire leads to different values for each technical solution. The material saving of PE100 will be always max. 40 %, but the number of fibre (or steel) layers and the weight of such fibres can be different.

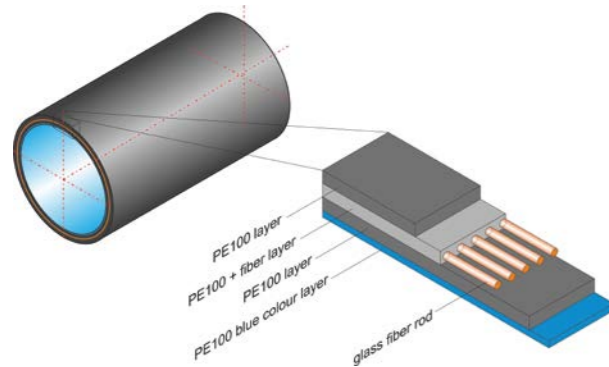

diameter range: DN 800 mm up to DN 4000 mm

0300	0900	1500	2100	2700	3300	3900
0400	1000	1600	2200	2800	3400	4000
0500	1100	1700	2300	2900	3500	4500
0600	1200	1800	2400	3000	3600	5000
0700	1300	1900	2500	3100	3700	
0800	1400	2000	2600	3200	3800	

Standard sizes in blue color, special sizes in red color.



Boyke Technology GmbH
Gerberstrasse 41
D-51789 Lindlar
info@boyke-tec.de
www.boyke-tec.de

bauku extrusion technology UG
Gerberstrasse 41
D-51789 Lindlar
info@bauku.com
www.bauku.com